

4K VA – 20K VA UPS

EMC Statements

CISPR 22

NOTICE: Pursuant to CISPR 22 rules, this product has been tested and thereby complies with the conditions of a Class A digital device, which have been established for offering sufficient protection against dangerous interference for installation in a residential area. Installation and use of the equipment should comply with the instructions provided in order to avoid such interference due to the amount of radio frequency energy that is radiated and generated by the equipment. In spite of this, we cannot assure that a certain amount of interference may not occur in some installations. If, by turning on and off, it can be deduced that your radio or television reception is found to be influenced by harmful interference from the equipment, it is recommended to use one of the following preventive measures:

- Place the receiving antenna in a separate location or orientation.
- Ensure a greater distance is achieved between the receiver and the equipment.
- Ensure that your equipment is connected to an outlet on a separate circuit than the receiver.
- Contact a technician experienced with radio and TV or a dealer for further assistance.

Declaration of Conformity Request

Units labeled with a CE mark comply with the following standards and directives:

- Harmonic Standards: EN 50091-1-1 and EN 50091-2
- EU Directives:73/23/EEC, Council Directive on equipment designed for use within certain voltage limits

93/68/EEC, Amending Directive 73/23/EEC

89/336/EEC, Council Directive relating to electromagnetic compatibility

92/31/EEC, Amending Directive 89/336/EEC relating to EMC

The EC Declaration of Conformity is available upon request for products with a CE mark.

■ **User's and Installation Manual** ■

CONTENTS

1. Introduction	1
2. System description	1
2.1 General description.....	1
2.2 System configuration	3
3. Safety information	4
4. Storage	5
5. Installation	5
5.1 Environment	5
5.2 Rear panel views	6
5.3 Connection to mains and loads (4000 - 20000 VA).....	12
5.4 Default settings at the factory	16
6. Computer and alarm connections	17
6.1 EPO port (emergency power off)	18
7. User's guide to operations	18
7.1 Starting and shutting down the UPS	18
7.2 Button operation	19
7.3 Control panel functions.....	20
7.4 Interpreting UPS messages.....	25
7.5 Trouble shooting	26
8. Maintenance	27
9. Technical Specifications	28
10. VGD RM 6KVA(3U+3U) Mechanical	34

IMPORTANT SAFETY INSTRUCTIONS

SAVE THESE INSTRUCTION

- **CAUTION (UPS Having Internal Batteries):** Risk of electric shock - Hazardous live parts inside this unit are energized from the battery supply even when the input AC power is disconnected.
- **CAUTION (No User serviceable Parts):** Risk of electric shock, do not remove cover. No user serviceable parts inside. Refer servicing to qualified service personnel.
- **CAUTION (Non-isolated Battery supply):** Risk of electric shock, battery circuit is not isolated from AC input, hazardous voltage may exist between battery terminals and ground. Test before touching.
- **WARNING (Fuses):** To reduce the risk of fire, replace only with the same type and rating of fuse.
- **WARNING:** Intend for installation in a controlled environment.
- **CAUTION:** Do not dispose of batteries in a fire, the battery may explore.
- **CAUTION:** Do not open or mutilate the battery, released electrolyte is harmful to the skin and eyes.
- **CAUTION:** A battery can present a risk of electric shock and high short circuit current. The following precaution should be observed when working on batteries
Remove watches, rings or other metal objects.
Use tools with insulated handles.
- To reduce the risk of electric shock, disconnect the UPS from the mains supply before installing a computer interface signal cable. Reconnect the powers cord only after signaling interconnections have been made.
- Servicing of batteries should be performed or supervised by personnel knowledge of batteries and the required precautions. Keep unauthorized personnel away from batteries.

The instructions contained within this safety manual are deemed important and should be closely followed at all times during installation and follow-up maintenance of the UPS and batteries.



CAUTION

The unit has a dangerous amount of voltage. If the UPS indicator is on, the unit's outlets may have a dangerous amount of voltage even when not plugged into the wall outlet because the battery may continue to supply power.

Care should be taken to undertake installation indoors free from electrically-conductive particles which is under temperature and humidity control in order to reduce the risk of electric shock.

It is best to disconnect the device using the power supply cord. Ensure that the equipment is placed in a position near the outlet where easily accessible.

Except replacing the batteries, all servicing on this equipment must be carried out by qualified service personnel.

Before conducting any maintenance, repair or shipment, first ensure that everything is turned off completely and disconnected.

For additional safety instructions, please use the Safety Manual as reference.

Special Symbols

The following symbols used on the UPS warn you of precautions:



RISK OF ELECTRIC SHOCK – Please observe the warning that a risk of electric shock is present.



CAUTION: REFER TO OPERATOR'S MANUAL - Refer to the operator's manual for additional information, such as important operating and maintenance instructions.



SAFE GROUNDING TERMINAL - Indicates primary safe ground



LOAD ON/OFF - Pressing this button turns on/off the output receptacles and the Indicator light.



Please do not discard the UPS or UPS batteries as the UPS may have valve regulated, lead-acid batteries. Please recycle batteries.

1. Introduction

The information provided in this manual covers single phase 5000 – 20000 VA, uninterruptible power systems, their basic functions, operating procedures, and emergency situations, also including information on how to ship, store, handle and install the equipment. Only detailed requirements of the UPS units are described herein, and installation must be carried out in accordance with this manual. Electrical installations must also carefully follow local legislation and regulations. Only qualified personnel should conduct these installations as failure to acknowledge electrical hazards could prove to be fatal.

2. System description

Several different kinds of sensitive electrical equipment stay protected by a UPS (Uninterruptible Power System) including computers, workstations, process control systems, telecommunications systems, sales terminals, other critical instrumentation, etc. The purpose of the UPS is to protect these systems from poor quality utility power, complete loss of power, or other associated problems.

Electrical interference abounds in many forms causing problems in AC power, from lightning, power company accidents and radio transmissions to motors, air conditioners, and vending machines, among others. So protection of sensitive electrical equipment is vital to protect against power outages, low or high voltage, slow voltage fluctuations, frequency variations, differential and common-mode noises, transients, etc.

In order to prevent power line problems reaching critical systems causing damage to software, hardware and causing equipment to malfunction, the UPS helps by maintaining constant voltage, isolating critical load output if needed, and cleaning the utility AC power.

2.1 General description

As a double conversion on-line UPS, it is able to supply uninterrupted, clean single-phase power to your critical systems while keeping batteries charged continuously, regardless of whether utility power fails or not.

In event that a power failure lasts longer than a UPS backup time, it will shut down avoiding battery discharge, and as soon as voltage comes back, the UPS will automatically charge up and start recharging the batteries.

As shown in fig.1 block diagram:

- An input filter reduces transients on the mains
- For maintaining full battery charge, AC-power is rectified and regulated in the rectifier feeding power to the inverter and battery converter.
- DC power is converted to AC in the inverter passing it on to the load.
- Power is maintained from the battery during a power failure.
- The converter increases voltage appropriately for the inverter.

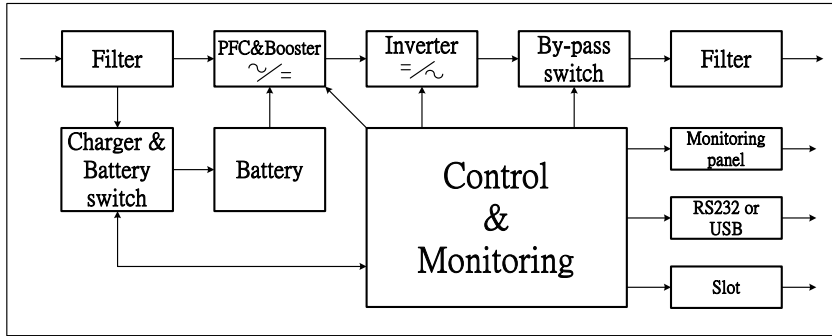

Fig.1. Block diagram

Efficiency Optimizer function

The Efficiency Optimizer function is a new feature for the UPS adding cost effectiveness, minimizing power loss and reducing power consumption. Alternating between bypass and on-line modes is achieved automatically and in accordance with the conditions of the utility power. On-line mode may be used during times of intermittent power supply, and bypass mode when power flows smoothly in order to obtain greatest efficiency. Irregularities can be detected in less than a second, and on-line mode reactivated immediately. Switching back to online mode occurs when input voltage is outside $\pm 10\%$ or nominal ($\pm 15\%$ selectable), when input frequency is outside of $\pm 3\text{Hz}$ or when no input line is available.

Although high efficiency is standard, the default operation is in on-line mode. Bypass can be activated in the LCD panel, though on-line can be run permanently if preferred.

Free Run Mode

The UPS operates in free run mode when input frequency is outside of the selected input frequency range. Free run mode is when output frequency does not match input frequency. When starting the UPS, the frequency regulation detected is 50 or 60 Hz $\pm 0.25\text{Hz}$. Please refer to chapter 7.2 if you want bypass available while running in free run mode.

Diagnostic tests

When you start the UPS, a diagnostic test is automatically executed that checks electronics, battery, and reports any problems on the LCD display.

An advanced battery management system always monitors the conditions of the batteries sends any forewarnings if replacement is needed. Otherwise every 30 days of normal mode operation, a battery discharge test is performed and any problems reported on the LCD display.

Except during the first 24 hours after startup while the UPS is in charging mode (please see chapter 7.2), diagnostic tests can be performed manually from the front panel at any time.

2.2 System configuration

The UPS device and the internal backup battery make up the system. Depending on the site and load requirements of the installation, certain additional options are available as a tailored solution.

Planning a UPS system, the following should be taken into consideration:

- The total demand of the protected system shall dictate the output power rating (VA). Allow a margin for future expansion or calculation inaccuracies from measuring power requirements.
- Backup time needed will indicate the battery size needed. If load is less than the UPS nominal power rating then actual backup time is longer.
- The following options are available:
- External Battery Cabinets
- Transformer cabinets
- Maintenance bypass switches
- Connectivity options (relay card, SNMP/WEB card)

The following UPS models are available

Model	Backup time Internal batteries	Recharge time to 90% capacity
UPS 4000VA	4min	4 hours
UPS 5000VA	4min	4 hours
UPS 6000VA	7min	4 hours
UPS 8000VA	4min	4 hours
UPS 10000VA	4min	4 hours
UPS 12000VA	8min	4 hours
UPS 15000VA	6min	4 hours
UPS 20000VA	4min	4 hours

Additional External Battery Cabinets are available if more back-up time is needed.

3. Safety information

Information presented here is vital to all personnel and please also read the UPS safety manual.

Storage and Transportation

Please handle with extreme caution since a high amount of energy is contained with the batteries. Always keep the unit in position as marked on the packaging and never drop the unit.

Installation

If flammable substances such as gases or fumes are present or if the room is airtight, a safety hazard situation exists, in which no electrical equipment should be operated.

The instructions in this manual explain how to install the UPS safely. Not acknowledging such electrical hazards may be fatal, so keep this manual for all future reference.



WARNING!

It is strongly advisable not to open the UPS cabinet as the components have very high voltage and touching them may be fatal. Only a technician from the manufacturer or an authorized agent may service the unit.

This UPS unit's output receptacles carry live voltage even when not connected to a power supply as it has its own energy source.

User's operations

The only operations that users are permitted to do are:

- Turning the UPS unit on and off
- Operating the users interface
- Connecting data interface cables

All such operations are to be performed exactly as instructed in this manual. The greatest care possible must be taken for any of these operations and any change thereof may prove very hazardous to the operator.

4. Storage

Please adhere to the following instructions if the UPS is not installed immediately:

- Store the equipment as is in its original packing and shipping carton
- Do not store in temperatures outside the range of +15°C to +25°C.
- Ensure that the equipment is fully protected from wet or damp areas and from moist air.

In order to maintain the vitality of the batteries, ensure that the UPS is recharged every 6 months for at least 8 hours.

5. Installation

5.1 Environment

Ensure that all environmental concerns and requirements are met according to these technical specifications, otherwise the safety of installation personnel cannot be guaranteed and the unit may malfunction.

Ensure that you remember the following when locating the UPS system and battery options:

- Avoid extremes of temperature and humidity. Maximal battery life can be attained with a recommended temperature range of 15 °C to 25 °C.
- Provide protection for the equipment from moisture.
- Space and ventilation requirements must be met. Ensure there is 100mm behind and 50mm on the sides of the UPS for ventilation.
- Ensure that the front of the UPS remains clear for user operation.

The External Battery Cabinets has to be installed next to the UPS or under the UPS.

Caution! The UPS and the External Battery Pack are to be installed at the same location. In case, the UPS and the External Battery Pack are installed outside of visible distance, then subject to the local inspection authority, User will need to add a Safety disconnect adjacent to the UPS to provide safety isolation.

5.2 Rear panel views

4K/5KVA (120VDC) Rear panel

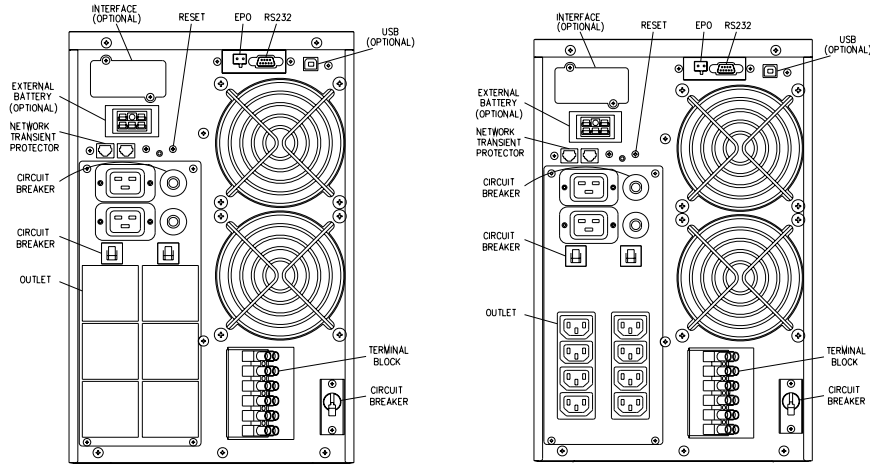

VGD-4KVA REAR PANEL
(230V E/F/G/I TYPE)

VGD-4KVA REAR PANEL
(230V IEC TYPE)

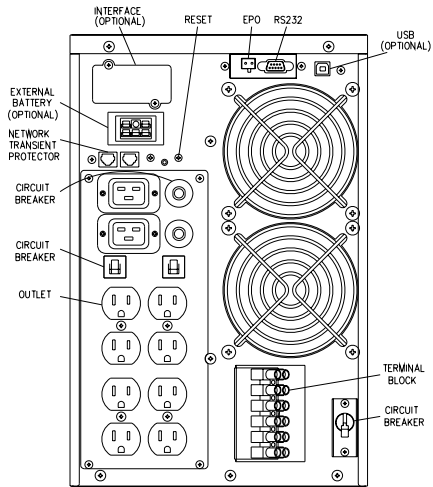

VGD-4KVA REAR PANEL
(230V NEMA TYPE)

6KVA Rear panel (Without ISO)

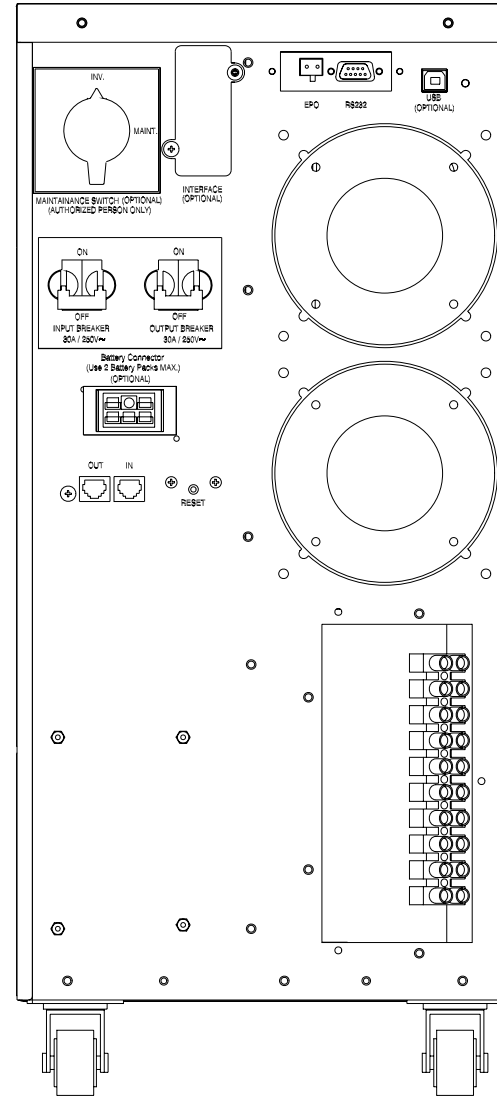

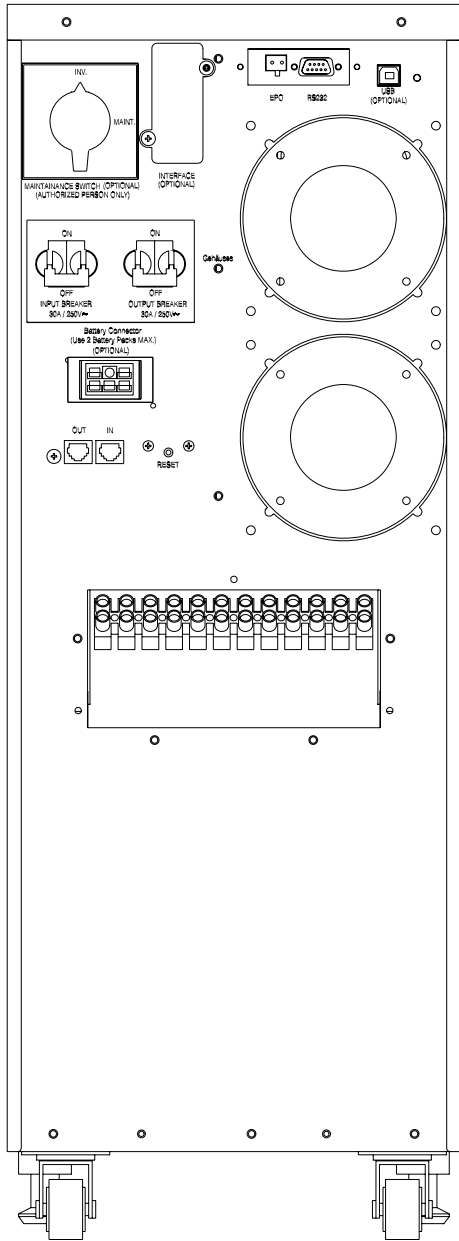

6KVA Rear panel
(With ISO)

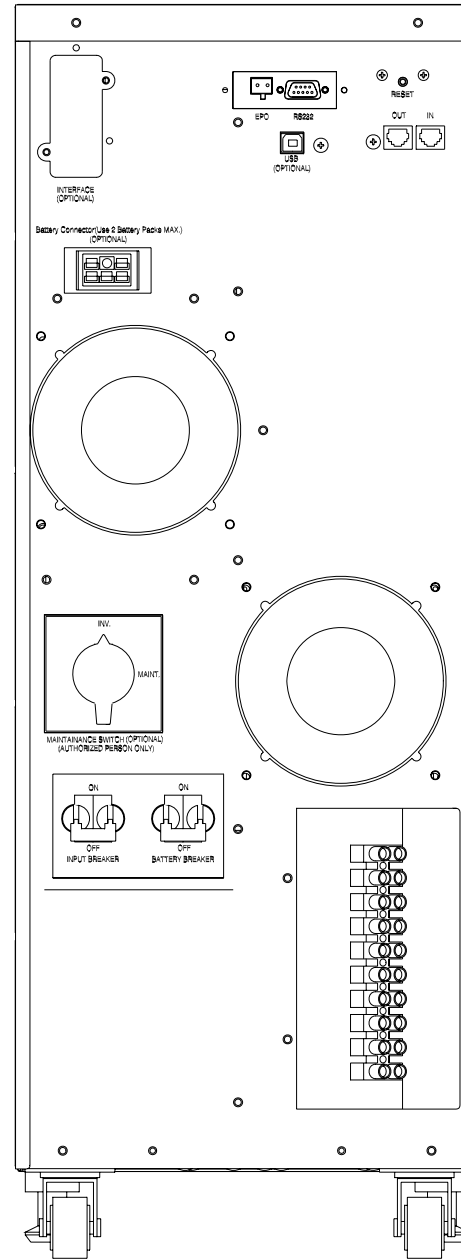

8K~10KVA
Rear panel
(Without ISO)

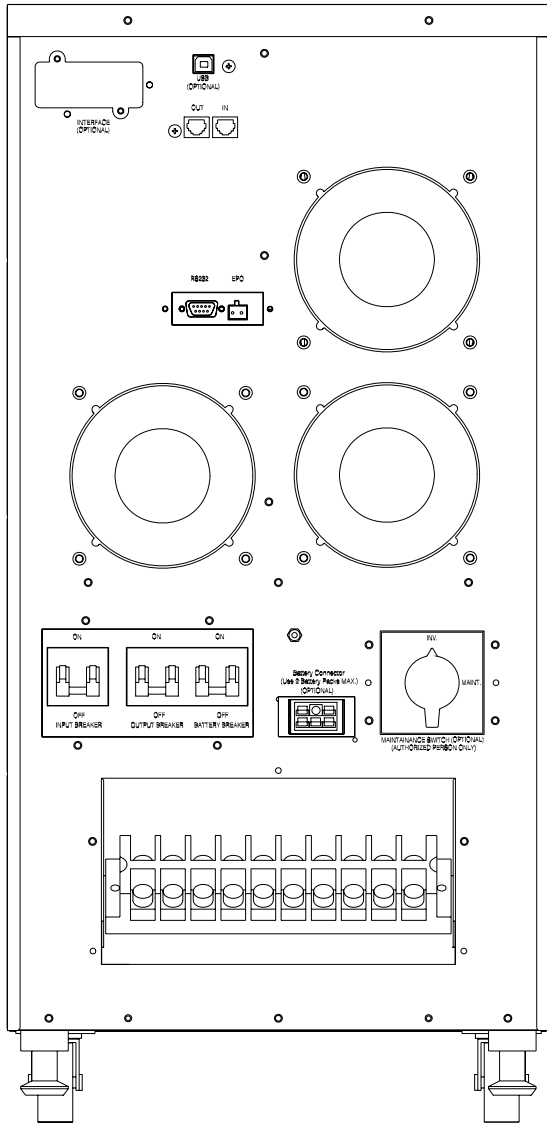

8K~10 KVA
Rear panel
(With ISO)

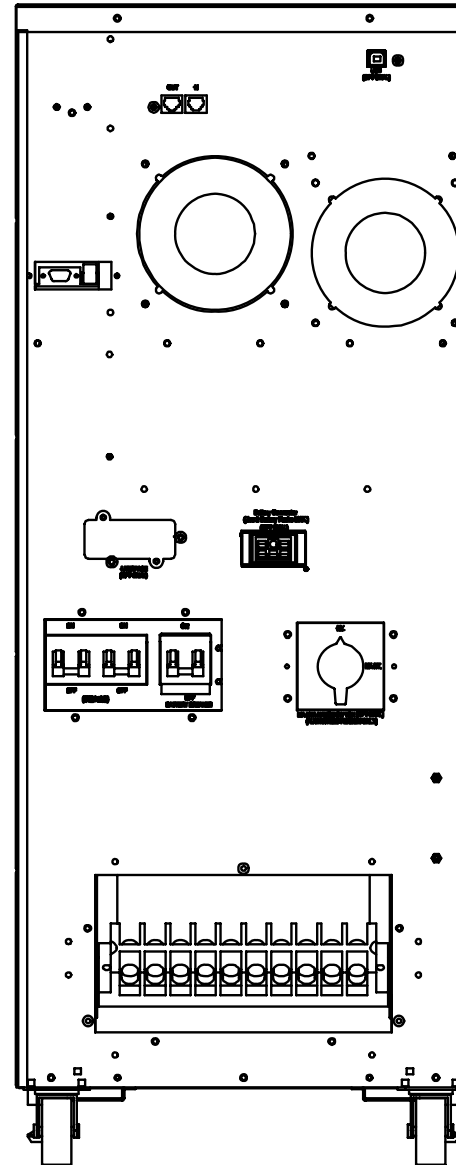

12KVA Rear panel
(ISO and With ISO)

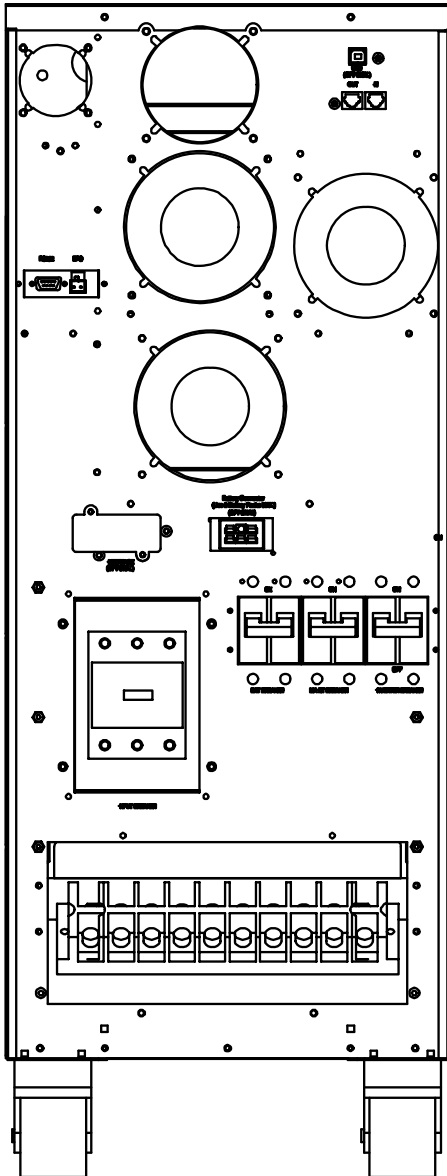

15/20 KVA Rear panel
(ISO and With ISO)

5.3 Connection to mains and loads (4000 - 20000 VA)

Only qualified specialists or technicians who conform to applicable safety standards may carry out the installation of this equipment. The installation must further comply with all local legislation and regulations.

Follow all installation and safety instructions very carefully, otherwise those performing installation may suffer from a hazardous situation and the UPS or load connections may also be damaged.

The high voltage and current contained within the UPS equipment can injure or kill personnel and damage equipment.

For electrical installation, closely observe the nominal current rating of the source.

Installing External battery cabinets

- First disconnect the UPS from mains and loads before attempting an External Battery Cabinet installation.
- Use the battery cable provided with the External Battery Cabinet to connect the External Battery Cabinet to the UPS. Connect a second battery cabinet to the first one with the cable provided if more than one is to be installed.
- Be aware of UPS parameters and changing the Battery pack quantity when using the external battery cabinets (see chapter 7.2)

Installing UPS

- Ensure that the installation site has all electrical connections properly carried out. In addition, refer to figures 2 and 3 to check the fuse and cable dimensions.
- Isolate and secure the source against reclosing. Both input and output circuit breakers (located in the back) must be "OFF".
- Refer to figure 2 for single cable input and figure 3 for dual cable input. Connect the UPS according to these diagrams. If installing dual cables, the interconnection jumper (b*) needs to be removed as in figure 2. Fuse and cable sizes are given in figure 3.
- During installation, if it cannot be determined that neutral is grounded or the identification of the neutral status of the mains supply is unreliable, an additional two pole disconnect device is necessary in the building installation.
- At the back of the unit you will find the Emergency Power Off (EPO), which when open will immediately shut down the logic circuit output of the UPS as in figure 2 and 3. Wiring the EPO signal is optional.
- **Caution!** Local safety requirements may require a separate external Emergency Power Off that opens output circuit breakers, and if so, use

figures 2 and 3 for proper installation. Refer to local wiring rules.

- Should computer or alarm connections be used, use connections according to chapter 6 of the manual provided with that option. The connections can be referred to on the rear panel.
- The installation is now complete.

b*) removable jumper when dual input used

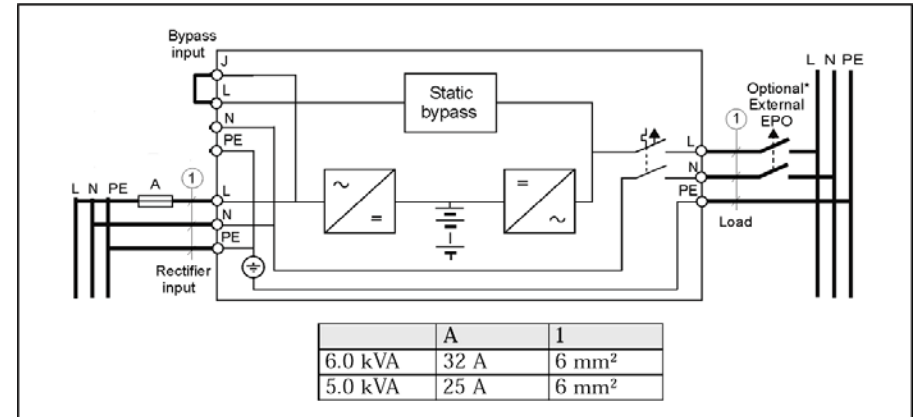

Fig. 2

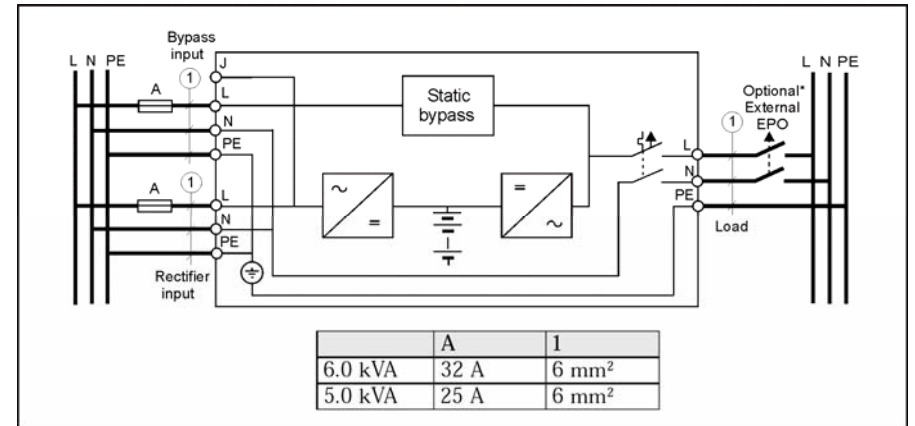

Fig. 3.

* Only required if demanded by that of local wiring rules.

5.4 Default settings at the factory

On the LCD display you will find several of the UPS parameters to select. Default settings are as follows:

Settings	Selection	Factory default
Output Voltage Setting	208/220/230/240 Vac	230V (FOR HV series)
Input/Bypass Voltage	±10% +10/-15% +15/-20%	+10/-15%
Input/Frequency	±2% ±5% ±7%	±5%
HE Mode Setting	On/Off	Off
Free Run Mode	On/Off	On
Bypass Enable/Disable at free run mode	Disable/Enable	Disable
Alarm silence	On/Off	Off
Site wiring alarm	Enable/Disable	Disable
External Battery pack setting	0, 1, 2	0

You may change default settings, but we recommend that this is done after installation and before starting up loads. Read UPS configurations in chapter 7.2 for more information.

6. Computer and alarm connections

At the back of the UPS is an interface allowing direct communication with your computer system, the location of which can be found in figure 4. There is a RS232 serial data interface, one USB data interface and an emergency power off switch supplied. However, the RS232 port cannot be used when the USB interface is in use.

In addition there is an optional interface slot that allows you to install different communications cards. It can be used parallel with either the RS232 or USB ports.

Currently there are two cards available for the optional interface slot. An SNMP/WEB card allows management and monitoring over a network or internet, and the AS/400 card allows voltage free relay contacts. Your local dealer will have more information about these option cards.

Connecting the UPS to a Computer

The communication device for the UPS and PC comes as a complete package with power management software. Only the communication cable provided with UPS may be used to connect to your computer, which is accomplished through the UPS RS232 port. Also ensure that the operating system on your computer is supported. Instructions provided in the power management software will help with this installation.

Other advanced power protection solutions such as SNMP are provided by your dealer.

RS-232 Standard Interface port

The RS-232 interface uses a 9-pin female D-sub connector. This information consists of data about utility, load and the UPS. The interface port pins and their functions are identified in the following table.

Pin #	Signal name	Direction (re UPS)	Functions
2	TxD	Output	TxD Output
3	RxD	Input	RxD / Inverter Off Input
5	Common		Common
6	CTS	Output	Ac Fail Output
8	DCD	Output	Low Battery Output
9	RI	Output	+12 VDC Power

Caution! Max rated values 12Vdc/50mA

Fig.4

USB port (option)

Connecting the UPS to your computer is accomplished through the USB port on the back of your computer. USB compliant hardware and operating system will be necessary including installation of a UPS driver. The serial port cannot be used when using the USB port. The USB cable is standard and can be bought separately.

6.1 EPO port (emergency power off)

A customer-supplied switch located remotely can be used to open the EPO connection and allows UPS output receptacles to be switched off. Since the EPO shuts down the equipment immediately, orderly shutdown procedures are not followed and not by any power management software. The UPS will have to be manually restarted in order to regain power to the outlets.

7. User's guide to operations

Necessary information for operation of the unit is covered in this chapter. Normally the UPS runs automatically, but on those few occasions such as just after installation, all the starting and shutting down procedures are described herein.

7.1 Starting and shutting down the UPS

Starting the UPS

- Ensure that installation was correct and successful and that the input power cable is connected to a well-grounded outlet.
- The UPS can be started by pushing the "ON/OFF" button on the front panel.
- The UPS should now start its inspection of: internal functions, main synchronization and inverter startup. Then power should start to be supplied via the terminal block.
- During this inspection, the LCD will display "Ready on". The LED shall light up when output power has commenced and the LCD will display "Line mode".
- Switch on the loads.

Shutting down the UPS

- Shut down and turn off the loads.
- Push the "ON/OFF" button on the front panel for two seconds. The alarm will sound and the UPS will shut down.
- The LCD will display UPS OFF for a few seconds.
- In emergency situations, the EPO located on the back of the unit should be used.

7.2 Button operation

Please note the five operating buttons on the front panel:

1. "ON/OFF" button:
 - (a) Push "ON/OFF" button (at least 1 seconds) to turn on the UPS.
 - (b) When UPS is working, push the "ON/OFF" button(at least 2 seconds) to turn off the UPS.
2. "STATUS" button:

Use this button to check content of UPS and the method is listed below:

- (a) Push the "STATUS" button (at least 2 seconds) to check content of UPS. Each content can be displayed by pressing at once, and it has fifteen kinds of function to be checked.
 - (b) If no pressing within 10 seconds, it will return to original status.
3. "FUNC" button:

Each function can be enabled by pressing this button & "ENTER" button.

- (a) Push the "FUNC " button (at least 2 seconds) to choose which function that you want. Each content can be displayed by pressing at once, and it has fourteen kinds of function to be checked.
 - (b) After choosing the function, push the "ENTER" button to enter the function that you want.
 - (c) Push the "FUNC" button to choose other function again.
 - (d) Push the "ENTER" button to enable your function.
 - (e) Push the "ENTER" button to confirm and enable your function.
 - (f) If no pressing within 10 seconds, it will return to original status.
4. "ENTER" button:

Use this button to enter 、enable or confirm the function that you want.
 5. "ESCAPE" button:

Use this button to return to main display(Line mode or Battery Mode).

7.3 Control panel functions

Operation of the UPS is indicated on the monitor panel with five LED indicators and an LCD screen. This display is also capable of alerting the user with audible alarms.

ON : This green LED is lit when UPS has been turned on.

ON-LINE : When the UPS is in normal or static bypass modes, there is voltage at the output terminals and this LED will light up in green.

ON-BAT : While operating in battery mode.

BYPASS : While operating in bypass mode, this LED will light up in yellow.

FAULT : If any internal error occurs in the UPS, this LED will light up in red and give off an audible alarm. Press any of the buttons on the front panel to turn off the alarm.

Status of the UPS, measurements and alarms are all indicated on the LCD screen.

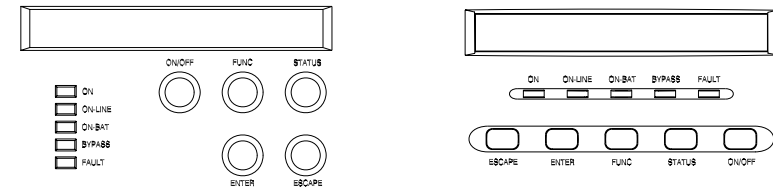

Control panel

Normal display

The UPS status is shown in normal display mode. From here you have a choice to go to UPS meters display and the Setting display by pushing the button.

UPS meters display

Various measurements are available through the UPS meters display; pressing the button will scroll through the following meters:

LCD message	Description
O/P VOLT= xxx, xV	Shows Output AC voltage
O/P FREQ= xx, x Hz	Shows Output Frequency
I/P VOL T= xxx, xV	Shows Input AC voltage
I/P FREQ= xx, x Hz	Shows Input Frequency
BAT VOLT= xx,xV	Shows Battery Voltage
O/P LOAD%= xx%	Shows Load % of max load
O/P W= xW	Shows Output Watts
O/P VA= xVA	Shows Output VA
O/P CURR= xA	Shows Output Current
BACKUP TIME= xx min	Shows Estimated Backup time in minutes
BAT CHARG= xx%	Shows approximate percentage of Battery capacity
TEMPERATURE= xxC	Shows approximate ambient temperature
BAT PACK NUM= x	Shows External Battery Pack Number
RATING = xxxxVA	Shows UPS Rating
CPU VERSION xx.x	Shows CPU Version

UPS configurations

1. Various settings that have been chosen are shown in the UPS setting display.
2. To enter configuration mode, press the “FUNC” button for one second. The first configuration parameter will be shown on the LCD display.
3. Press the “FUNC” button to scroll through the parameters.
4. Press the “ENTER” button to select the parameter.
5. Press the “FUNC” button to scroll through the options for the selected parameter.
6. Press the “ENTER” button to select the option.

You may be prompted to save the selection, if so press the “ENTER” button to either confirm or save your selection. Other options are saved and started automatically. See the table below for further details.

7. If no buttons are pressed (or user inactivity) for ten seconds, the UPS shall exit the configuration mode and return to normal mode displaying Line mode.

Caution!

The factory default settings do not necessarily have to be changed, although you are free to tailor the UPS to your specific needs.

Settings	LCD display	Explanation	Selection	Factory default
Output Volt.Setting	O/P V Setting	Select Nominal Voltage	208/220/230/240 V	230V
Input/Frequency	I/P F Setting	Select input frequency range when UPS goes into free run mode	±2% ±5% ±7%	±5%
Input/Bypass Voltage	I/P Bypass Set	Select Input Voltage range when bypass is available	±10% +10/-15% +15/-20%	+10/-15%
Free Run Mode	Free Run Set	Select if UPS can run in Free run mode (unsynchronized)	ON/OFF	ON
Bypass Enable/Disable at Free run mode	Bypass disable	If Enable is chosen, the UPS can go to bypass when unsynchronized.	Disable/Enable	Disable
He mode Setting	HE Mode Set	Select if UPS runs in high efficiency mode	ON/OFF	OFF
Force Manual Bypass	Manual bypass	Permanently force UPS to bypass. For service only.**	ON/OFF	OFF
Do Battery Test	Battery Test	Detect battery is normal or not.		
Silence Function	Silence Set	Enable or disable silence function	ON/OFF	OFF
Number of External battery Packs	Bat Cabinet Set	This setting is needed For UPS to predict Backup time	0 (only internal batteries) 1 (one external cabinet) 2 (two external cabinets)	0
Site wiring alarm	Sit Fault Set	You can enable or disable the site wiring alarm	Enable /Disable	Disable
Select Language	Language	Select load language	English, German, French, Spanish, Italian.	English
Set Generator Mode	Generator	Set unit in generator mode.***	ON/OFF	OFF
Set RS232 communication	RS232 Control	Set RS232 communication enable or disable	Enable/Disable	Enable

Manual test of the UPS

Manual UPS or Manual Battery tests can be conducted from the UPS configuration as well and are functional even when the UPS is not charging the battery.

Manual Battery test: Scroll the parameters until Manual Bat test displays on the LCD.

Press the “ENTER” button twice.

**) Note: In order for the UPS and power management software to operate normally, Manual Bypass should always be set to OFF as the load will not be protected by the unit when Manual Bypass is ON. This is aimed for operating an external maintenance bypass switch.

**) Note: You should turn UPS off and keep the AC power before you use “Generator” function. (even you want to select “Generator\OFF” to back to normal mode).

7.4 Interpreting UPS messages

Troubleshooting procedures described here give simple instructions in determining UPS malfunctions.

Start the troubleshooting procedure if you witness any alarm indication on the control panel.

Alarm indicators

The UPS gives the following audible alarms:

- If UPS is on battery and the ON BATTERY LED is on, UPS will beep every 5 seconds.
- If the battery capacity is low and the ON BATTERY LED is flashing, the UPS will beep twice every 5 seconds.
- If UPS is on bypass and the BYPASSED LED is on, UPS will no beep.
- If UPS has an internal fault and the ALARM LED is on, the UPS will give a constant audible alarm displaying the cause on the LCD display.

Silencing an alarm

By pressing any of the three buttons on the front panel, the alarm can be turned off, except when the battery is low, which will cause the alarm to resound.

On the LCD display, you can also choose silent alarm mode which will not warn you of any malfunction audibly.

7.5 Trouble shooting

Displayed on LCD	Audible Alarm	Alarm Description	What You Should Do
Output Overload	Two Beeps per second	The UPS is overloaded (in Line Mode). Your equipment needs more power than the UPS can provide. The UPS operates in bypass.	Shut off the least important equipment connected to the UPS. If this solves the overload problem, the UPS will switch from bypass back to normal operation.
Battery Test	No Beeps	The UPS is doing a battery test.	No action needed. The UPS will return to normal operation when it successfully completes the battery test.
Over-Charge	Constant beep	Batteries are overcharged.	Turn off protected loads. Turn off UPS and call your local dealer
Low Battery	2 beeps every 5seconds	The unit is operating on Battery Power and will shut down soon due to very low battery voltage	The unit will restart Automatically when acceptable power returns.
On-Battery	Once every 5 seconds	The unit is operating on Battery Power.	Save your data and perform a controlled shutdown.
Charger Failure	Constant beep	Charger has failed.	Phone the local dealer
Over-Temperature	Constant beep	High ambient Temperature.	Make sure the unit's fans and vent holes are not blocked, and make sure the ambient surrounding temperature is not above 40 degree C. If these conditions did not solve the problem, call your service representative.
Output Short	Constant beep	Output short circuit	Call the Local dealer
High output Voltage	Constant beep	High output voltage	Call the Local dealer
Low Output Voltage	Constant beep	Low output voltage	Call the Local dealer
Bus Fault	2 Beeps per second	High internal DC bus Voltage.	Turn off protected loads. Turn off UPS and call your local dealer
Site wiring Fault	1 Beep per second	Voltage detected Between Neutral and Ground	UPS mains connector polarity Wrong. Rotate the connector (Schuko). UPS installed to mains supply without ground. See page 15 on how to disable the Site wiring alarm
Line abnormal	1 Beep per second	Wrong AC Line backed up during auto restart	

8. Maintenance

With a minimal amount of maintenance, you can expect the UPS to application, otherwise consider changing the batteries. have a long life free of trouble. The most critical issues for the reliability of the UPS are environmental issues. Ensure that the temperature and humidity are always according to specifications and keep the area around the unit clean and dust free.

At a temperature of 25°C, the typical battery lifetime is 4 years.

Also check at regular intervals of 6 to 12 months whether the back-up time of the battery is adequate for its



WARNING!

Batteries may cause electrical shock or burn from high short circuit currents. Please observe the following precautions: 1. Remove jewelry and metal objects such as watches and rings. 2. Use tools that have insulated handles. 3. Keep tools and other metal objects from contacting and away from the batteries.

ELECTRIC ENERGY HAZARD. Do not attempt to rewire, alter, or change any battery wiring or connectors. Attempting to make such alterations can cause injury.

Replace the batteries with the same number and type as originally installed batteries.

DO NOT DISCONNECT the batteries while UPS is in Battery mode.

9. Technical Specifications

For model with 3 Phase in 1 Phase out

Tower model (with LCD display)		8K31	10K31	12K31	15K31	20K31
Capacity	Capacity (VA)	8000VA	10000VA	12000VA	15000VA	20000VA
	Capacity (W)	5600W	7000W	8400W	10500W	14000W
Input	Voltage/Load	208/360V, 220/380V, 230/400V, 240/415V(3Φ5V)				
		Load Capacity		Voltage/Range		Load Capacity
		208~241V	0~25%	312~478V		0~100%
		242~276V	0~40%			
277~311V	0~75%					
Frequency	50/60 Hz Auto Sensing					
Output	Voltage (on battery)	100V, 110V, 115V, 120V / 208V, 220V, 230V, 240V +/-2% (Selectable Output Voltage)				
	Frequency (on battery)	50 / 60 Hz +/-0.5%				
	Transfer Time	0 ms				
	Overload Recovery	Auto transfer to UPS				
	High Efficiency mode (AC to AC)	> 97 %				
	UPS Design Technology	On-Line / Fully digitized microprocessor controlled				
	Output Wave Form	Sine wave				
	Harmonic distortion	< 3% of T.H.D. at linear load				
	Crest Factor	3 : 1				
	Protection and Filtering	Surge Protection	IEC61000-4-5 level 3			
Overload Protection		125% for 1 minutes and 150% for 10 seconds 130% for 10 seconds and 150% for 1.5 seconds (On-battery)				
Short Circuit Protection		UPS output cut off immediately or input fuse / circuit breaker protection				
System Display/ Warning	Visual Display (LED model)	UPS on(green), line-mode(green), battery mode(yellow), bypass(yellow), fault(red)				
	Visual Display (LCD model)	Input / output voltage, input / output frequency, on-line mode, back up mode, battery capacity, load level				
	Audible Alarm (Battery back-up)	Beep every 5 sec				
	UPS Fault	Continuous beeping sound and LCD display				
Battery	Communication	RS-232 Serial Port and USB				
	Type	Sealed, maintenance-free lead acid batteries				
	DC Voltage (V) Battery (Tower)	240V / 12V7.2AH x 20	240V / 12V9AH x 20	240V / 12V7.2AH x 20 x 2SET	240V / 12V7.2AH x 20 x 2SET	240V / 12V9AH x 20 x 2SET
	Typical Recharge Time to 90% Full	4 hours				
	Management	Self-test, adjustable battery transfer points and alarm settings				
	Battery Protection	Cut off without draining any current when battery is low				
	Cold Start (DC start)	YES				
	Back Up Time (Tower model)	About 4~6 min Full load / 10~15min Half load				
Physical	Input Inlet	Hardwire				
	Receptacles	Hardwire				
	Dimensions W x D x H mm (inch) W/O ISOTR	257 x 690 x 715 (10.1" x 27.2" x 28.1")	342 x 690 x 878 (13.5"x27.2"x34.6")	342 x 863 x 905 (13.5" x 34.0" x 35.6")		
	Net Weight kg (lb) W/O ISOTR	80.0 (176.0)	176.5 (388.3)	175.0 (385.0)		
	Shipping Weight kg (lb) W/O ISOTR	101.5 (223.3)	206.5 (454.3)	196.0 (432.3)		
	Dimensions W x D x H mm (inch) W/ ISOTR	342 x 690 x 715 (13.4" x 27.2" x 28.1")	342 x 690 x 878 (13.5"x27.2"x34.6")	342 x 863 x 905 (13.5" x 34.0" x 35.6")		
	Net Weight kg (lb) W/ ISOTR	130.0 (286.0)	176.5 (388.3)	225.0 (495.0)		

	Shipping Weight kg (lb) W/ ISOTR	151.5 (333.3)	206.5 (454.3)	246.5 (542.3)
Environment	Operating Temperature	0~40°C / 32~104°F		
	Storage Temperature	-20~50°C / -4~122°F		
	Altitude	3,500 meters max		
	Audible Noise (1 meter from surface)	< 55 dB		
	Relative Humidity	0 ~ 95% humidity, non-condensing		

For Tower model

Tower model (with LCD display)		VGD-4000	VGD5000	VGD-6000	VGD-8000
Capacity	Capacity (VA)	4000VA	5000VA	6000VA	8000VA
	Capacity (W)	2800W	3500W	4200W	5600W
Output	Voltage (on battery)	208V, 220V, 230V, 240V +/-2% (Selectable Output Voltage) For 4K / 5K / 6K			
		100V, 110V, 115V, 120V / 208V, 220V, 230V, 240V +/-2% (Selectable Output Voltage) For 6K / 8K with output isolation transformer			
	Frequency (on battery)	50 / 60 Hz +/-0.5%			
	Transfer Time	0 ms			
	Overload Recovery	Auto transfer to UPS			
	High Efficiency mode (AC to AC)	> 95 %		> 97 %	
	UPS Design Technology	On-Line / Fully digitized microprocessor controlled			
	Output Wave Form	Sine wave			
	Harmonic distortion	< 3% of T.H.D. at linear load			
	Crest Factor	3 : 1			
Protection and Filtering	Surge Protection	IEC61000-4-5 level 3			
	Overload Protection	125% for 1 minutes and 150% for 10 seconds (On-line) 130% for 10 seconds and 150% for 1.5 seconds (On-battery)			
	Short Circuit Protection	UPS output cut off immediately or input fuse / circuit breaker protection			
System/Display Warning	Visual Display (LED model)	UPS on(green), line-mode(green), battery mode(yellow), bypass(yellow), fault(red)			
	Visual Display (LCD model)	Input / output voltage, input / output frequency, on-line mode, back up mode, battery capacity, load level			
	Audible Alarm (Battery back-up)	Beep every 5 sec			
	UPS Fault	Continuous beeping sound and LCD display			
Battery	Communication	RS-232 Serial Port and USB			
	Type	Sealed, maintenance-free lead acid batteries			
	DC Voltage (V) Battery (Tower)	120V / 12V7AH x 10	120V / 12V9AH x 10	240V / 12V7.2AH x 20	240V / 12V7.2AH x 20
	Typical Recharge Time to 90% Full	4 hours			
Management	Self-test, adjustable battery transfer points and alarm settings				
Battery Protection	Cut off without draining any current when battery is low				
Cold Start (DC start)	YES				
Back Up Time (Tower model)	4 min. Full load / 10 min. Half load	5 min. Full load / 13 min. Half load	About 4~6 min Full load / 10~15min Half load		
Physical	Input Inlet	Hardwire			
	Receptacles	IEC C13*8 ; C19*2		Hardwire	
	Dimensions W x D x H mm (inch) W/O ISOTR	257*537*440 (10.1"x21.1"x17.3")		257 x 590 x 570 (10.1"x23.2"x22.4")	257 x 690 x 715 (10.1" x 27.2" x 28.1")
	Net Weight kg (lb) W/ ISOTR	130.0 (286.0)		176.5 (388.3)	225.0 (495.0)

	Net Weight kg (lb) W/O ISOTR	50 (110)	86.0 (189.2)	80(176)
	Shipping Weight kg (lb) W/O ISOTR	53 (116.7)	106.0 (233.2)	101.5(223.3)
	Dimensions W x D x H mm (inch) W/ ISOTR	257 x 590 x 700 (10.1"x23.2"x27.6")		
	Net Weight kg (lb) W/ ISOTR	123.0 (270.6)	130 (286.0)	
	Shipping Weight kg (lb) W/ ISOTR	145.0 (319.0)	151.5 (333.3)	
Environment	Operating Temperature	0~40°C / 32~104°F		
	Storage Temperature	-20~50°C / -4~122°F		
	Altitude	3,500 meters max		
	Audible Noise (1 meter from surface)	50 dBA	< 55 dBA	
Conformance	Relative Humidity	0 ~ 95% humidity, non-condensing		
	Safety	UL 1778, CE		
	EMC (EMS / EMI)	IEC 61000-4, FCC Part 15, CISPR 22		
	Equipment Protection Policy	Warranty policy may vary depends on region		

Tower model (with LCD display)		VGD-10000	VGD-12000	VGD-15000	VGD-20000
Capacity	Capacity (VA)	10000VA	12000VA	15000VA	20000VA
	Capacity (W)	7000W	8400W	10500W	14000W
Output	Voltage (on battery)	100V, 110V, 115V, 120V / 208V, 220V, 230V, 240V +/-2% (Selectable Output Voltage)			
	Frequency (on battery)	50 / 60 Hz +/-0.5%			
	Transfer Time	0 ms			
	Overload Recovery	Auto transfer to UPS			
	High Efficiency mode (AC to AC)	> 97 %			
	UPS Design Technology	On-Line / Fully digitized microprocessor controlled			
	Output Wave Form	Sine wave			
	Harmonic distortion	< 3% of T.H.D. at linear load			
	Crest Factor	3 : 1			
Protection and Filtering	Surge Protection	IEC61000-4-5 level 3			
	Overload Protection	125% for 1 minutes and 150% for 10 seconds (On-line) 130% for 10 seconds and 150% for 1.5 seconds (On-battery)			
	Short Circuit Protection	UPS output cut off immediately or input fuse / circuit breaker protection			
System/Display Warning	Visual Display (LED model)	UPS on(green), line-mode(green), battery mode(yellow), bypass(yellow), fault(red)			
	Visual Display (LCD model)	Input / output voltage, input / output frequency, on-line mode, back up mode, battery capacity, load level			
	Audible Alarm (Battery back-up)	Beep every 5 sec			
	UPS Fault	Continuous beeping sound and LCD display			
	Communication	RS-232 Serial Port and USB			
Battery	Type	Sealed, maintenance-free lead acid batteries			
	DC Voltage (V) Battery (Tower)	240V / 12V9AH x 20	240V / 12V7.2AH x 20 x 2SET	240V / 12V7.2AH x 20 x 2SET	240V / 12V9AH x 20 x 2SET
	Typical Recharge Time to 90% Full	4 hours			
	Management	Self-test, adjustable battery transfer points and alarm settings			
	Battery Protection	Cut off without draining any current when battery is low			

	Cold Start (DC start)	YES		
	Back Up Time (Tower model)	About 4~6 min Full load / 10~15min Half load		
Physical	Input Inlet	Hardwire		
	Receptacles	Hardwire		
	Dimensions W x D x H mm (inch) W/O ISOTR	257 x 690 x 715 (10.1" x 27.2" x 28.1")	342 x 690 x 905 (13.5"x27.2"x35.6")	342 x 760 x 905 (13.5" x 29.9" x 35.6")
	Net Weight kg (lb) W/O ISOTR	80 (176)	130 (286)	207 (455.4)
	Shipping Weight kg (lb) W/O ISOTR	101.5 (223.3)	151.5 (333.3)	225 (495.0)
	Dimensions W x D x H mm (inch) W/ ISOTR	342 x 690 x 715 (13.4" x 27.2" x 28.1")	342 x 690 x 905 (13.5"x27.2"x35.6")	342 x 760 x 905 (13.5" x 29.9" x 35.6")
	Net Weight kg (lb) W/ ISOTR	130 (286)	180 (396)	274 (602.8)
Environment	Shipping Weight kg (lb) W/ ISOTR	151.5 (333.3)	201.5 (443.3)	292 (642.4)
	Operating Temperature	0~40°C / 32~104°F		
	Storage Temperature	-20~50°C / -4~122°F		
	Altitude	3,500 meters max		
	Audible Noise (1 meter from surface)	< 55 dB		
	Relative Humidity	0 ~ 95% humidity, non-condensing		
Conformance	Safety	UL 1778, CE		
	EMC (EMS / EMI)	IEC 61000-4, FCC Part 15, CISPR 22		
	Equipment Protection Policy	Warranty policy may vary depends on region		

For Rack mount model

RM model (with LCD display)		VGD-4000	VGD5000	VGD-6000	VGD-10000
Capacity	Capacity (VA)	4000VA	5000VA	6000VA	10000VA
	Capacity (W)	2800W	3500W	4200W	7000W
Output	Voltage (on battery)	208V, 220V, 230V, 240V +/-2% (Selectable Output Voltage)			
	Frequency (on battery)	50 / 60 Hz +/-0.5%			
	Transfer Time	0 ms			
	Overload Recovery	Auto transfer to UPS			
	High Efficiency mode (AC to AC)	> 95 %		> 97 %	
	UPS Design Technology	On-Line / Fully digitized microprocessor controlled			
	Output Wave Form	Sine wave			
	Harmonic distortion	< 3% of T.H.D. at linear load			
	Crest Factor	3 : 1			
Protection and Filtering	Surge Protection	IEC61000-4-5 level 3			
	Overload Protection	125% for 1 minutes and 150% for 10 seconds (On-line) 130% for 10 seconds and 150% for 1.5 seconds (On-battery)			
	Short Circuit Protection	UPS output cut off immediately or input fuse / circuit breaker protection			
System/Display Warning	Visual Display (LED model)	UPS on(green), line-mode(green), battery mode(yellow), bypass(yellow), fault(red)			
	Visual Display (LCD model)	Input / output voltage, input / output frequency, on-line mode, back up mode, battery capacity, load level			
	Audible Alarm (Battery back-up)	Beep every 5 sec			
	UPS Fault	Continuous beeping sound and LCD display			

Battery	Communication	RS-232 Serial Port and USB			
	Type	Sealed, maintenance-free lead acid batteries			
	DC Voltage (V) Battery (Tower)	TBD	TBD	240V / 12V7.2AH x 20	240V / 12V9AH x 20
	Typical Recharge Time to 90% Full	4 hours			
	Management	Self-test, adjustable battery transfer points and alarm settings			
	Battery Protection	Cut off without draining any current when battery is low			
	Cold Start (DC start)	YES			
Physical	Back Up Time (Tower model)	TBD	TBD	6 min. Full load / 15 min. Half load	4 min. Full load / 13 min. Half load
	Input Inlet	Hardwire			
	Receptacles	Hardwire			
	Dimensions W x D x H mm (inch)	TBD	428*597*260 18.9**23.5**10.2"	428*658*260 18.9**25.9**10.2"	
	Net Weight kg (lb)	TBD	86Kg (189lb)	110Kg (242lb)	
	Shipping Weight kg (lb)	TBD	100Kg (220lb)	130Kg (286lb)	
Environment	Operating Temperature	0~40°C / 32~104°F			
	Storage Temperature	-20~50°C / -4~122°F			
	Altitude	3,500 meters max			
	Audible Noise (1 meter from surface)	50 dBA	< 55 dBA		
	Relative Humidity	0 ~ 95% humidity, non-condensing			
Conformance	Safety	UL 1778, CE			
	EMC (EMS / EMI)	IEC 61000-4, FCC Part 15, CISPR 22			
	Equipment Protection Policy	Warranty policy may vary depends on region			

5/6K TB

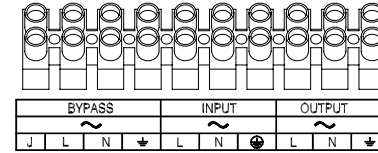

5/6K-ISO TB

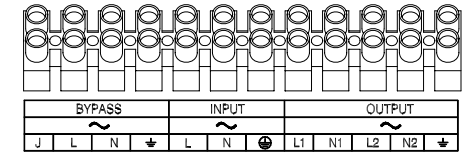

8/10/12K TB

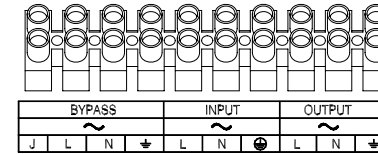

8/10/12K-3Ø TB

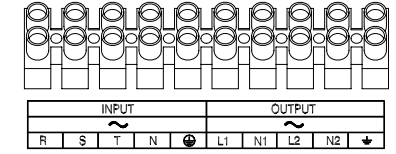

5/6/8/10/12K-ISO TB

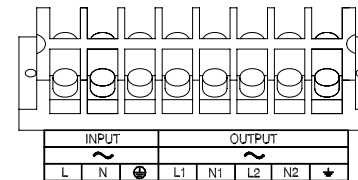

8/10/12K-ISO-3Ø TB

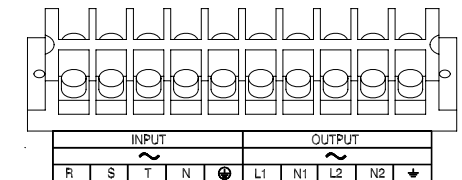

15/20K TB

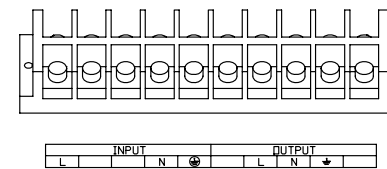

15/20K 3Ø TB

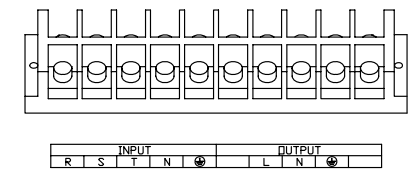

15/20K-ISO TB

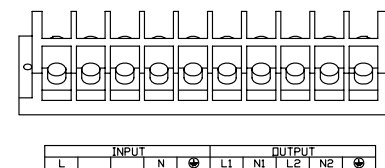

15/20K-ISO-3Ø TB

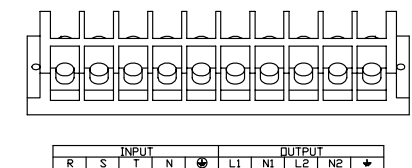

10. VGD RM 6KVA(3U+3U) Mechanical

A. VGD 6K RACK-MOUNT(3U+3U) DESIGN:

(1) BASIC COMPONENT: INCLUDING 3U-UPS & 3U-BATT. CABINET

FRONT VIEW

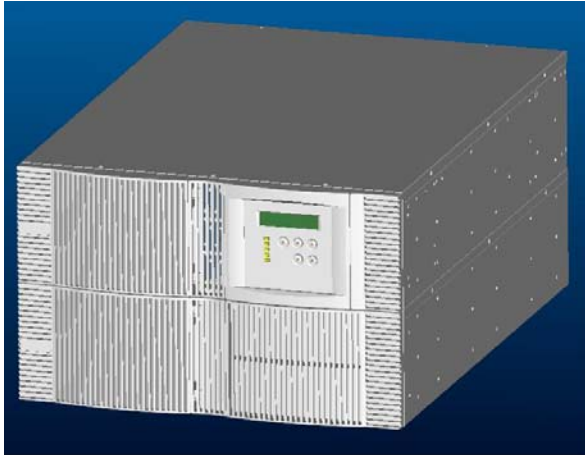

REAR VIEW

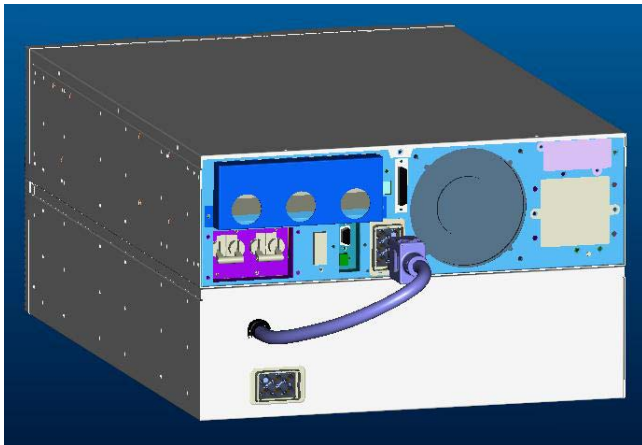

(2) UPS REAR PANEL COMPONENTS:

H. TERMINAL BLOCK

I. BREAKER

J. EXTERNAL BATTERY CONNECTOR

K. BYPASS SWITCH

L. SNMP SLOT

M. RS232 + EPO

N. TVSS

O. USB

P. REMOTE CONTROL PORT

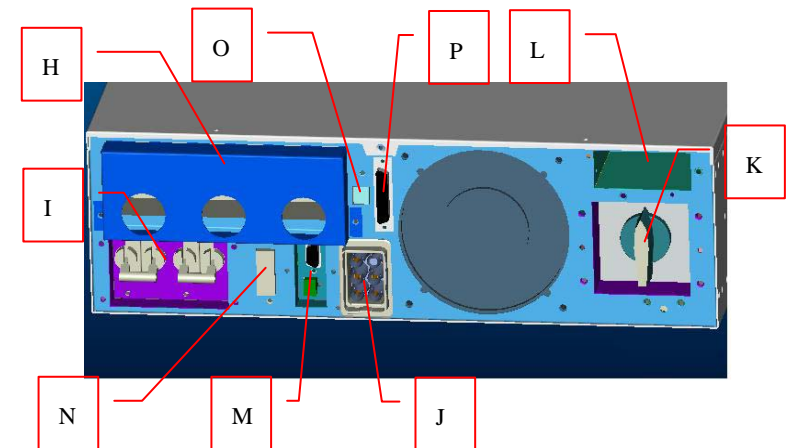

(3) Connect the Battery cabinet to UPS:

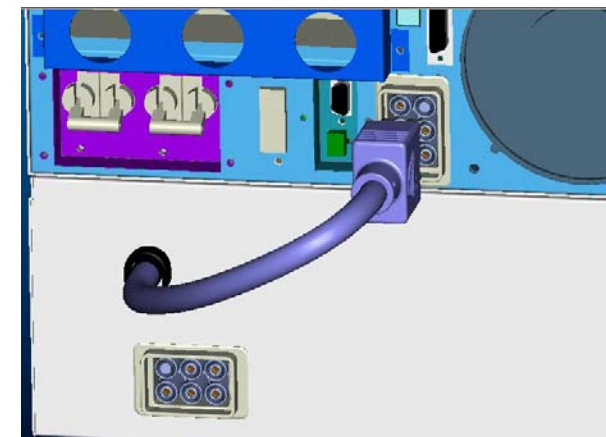

(4) **FEATURE of REMOTE CONTROL FUNCTION:**

- a. Remove the original right side panel and take apart the control panel unit. Then assemble the blank right side panel.

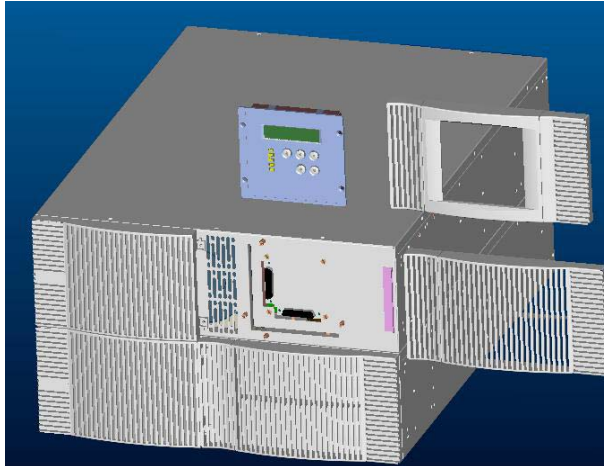

- b. **Connect the Control panel unit and Remote control port from rear side.**

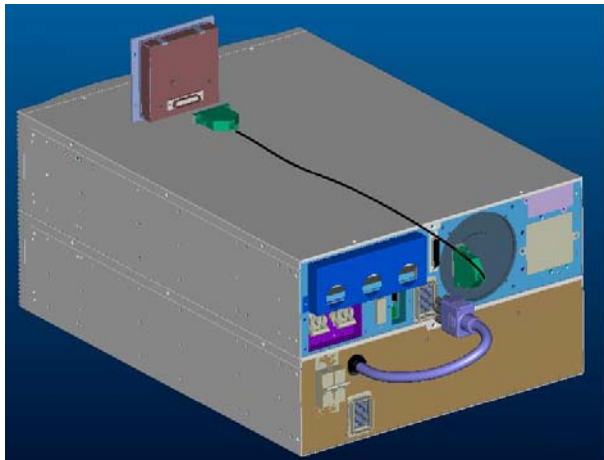

- c. **Running the remote-control function.**

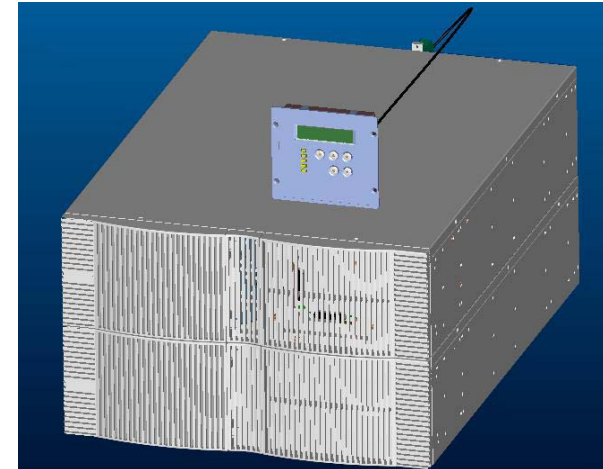

B. 5 in 1 FUNCTION BRACKETS on RACK-MOUNT 3U DESIGN:

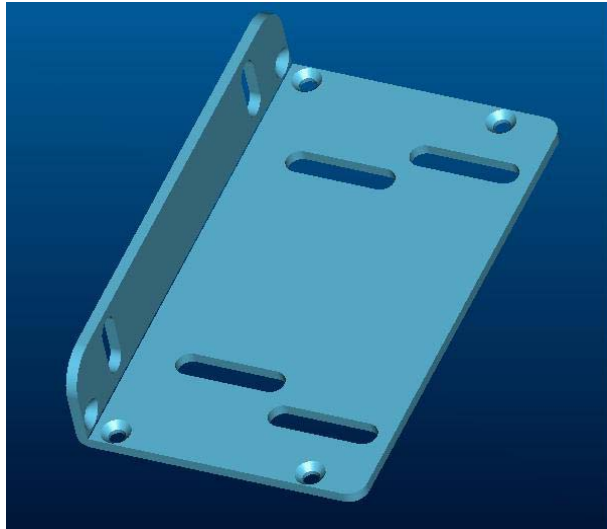

(1) 19" Rack installation:

Mount the 3U rack-mount in a 19-inch EIA 310 C standard rack.

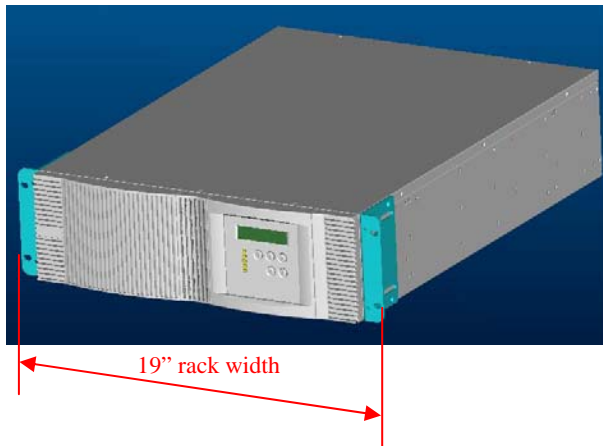

(2) 23" Rack installation:

Change the position of the two mounting brackets to mount the 3U rack-mount in a 23-inch EIA 310 C standard rack.

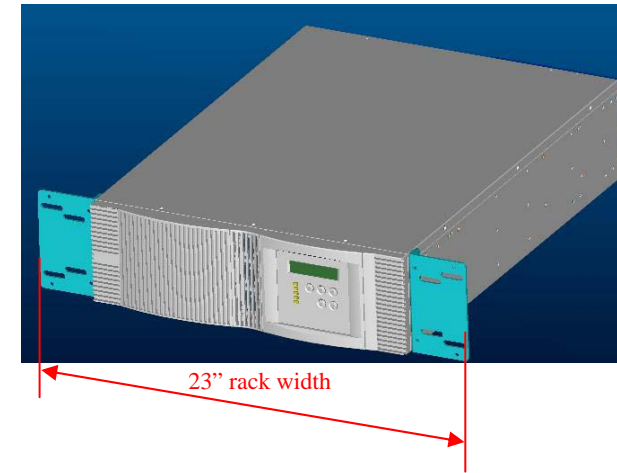

(3) Tower installation:

- a. Move the mounting brackets from the front to the side and attach the brackets by screws. Then let the UPS stand with the vertical direction as the below pictures shown.
- b. Rotate the control panel unit from horizontal to vertical direction.

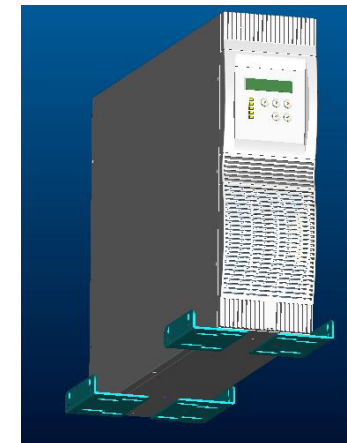
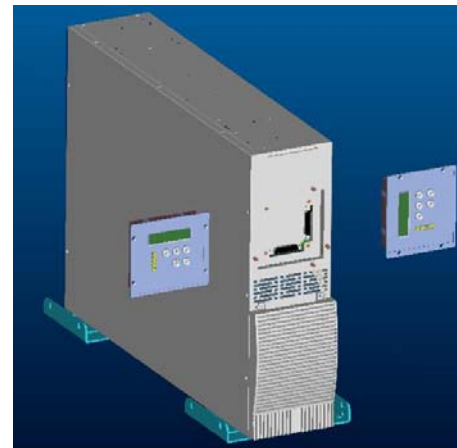

(4) Wall installation:

Move the mounting brackets from the front to the side and attach the brackets by screws. Then mount the UPS to the wall as the below pictures shown.

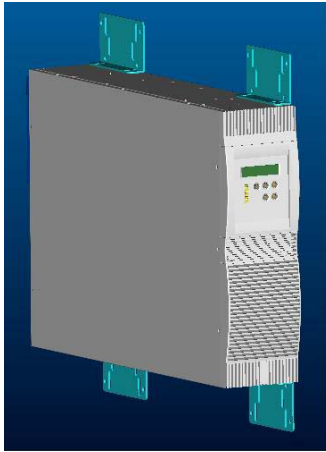

(5) Installation with rear Bracket:

We can use bracket to support the rear side of UPS or battery cabinet.

